

METRIC

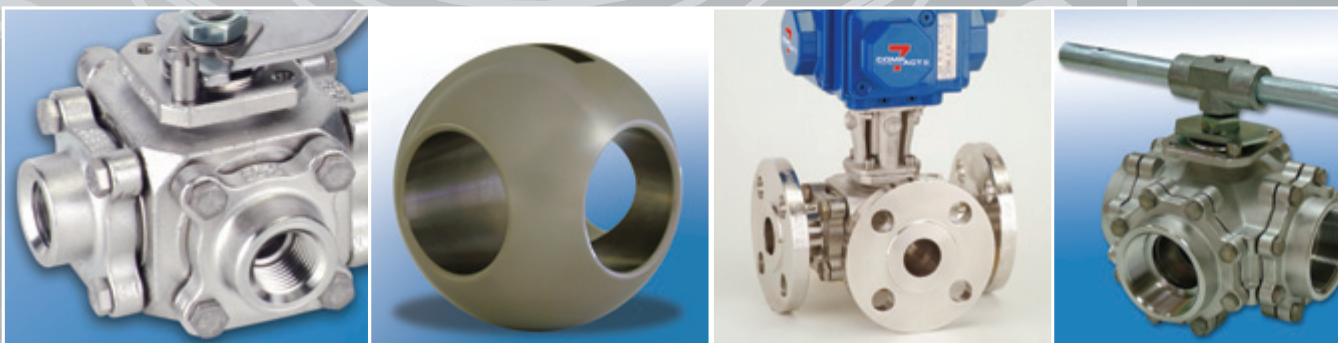

## 3,4,5 WAY VALVES

61P/62P SERIES



 **HABONIM**  
Industrial Valves & Actuators

DEDICATED TO INNOVATION

# 3,4,5 WAY VALVES

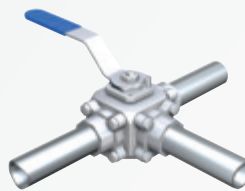
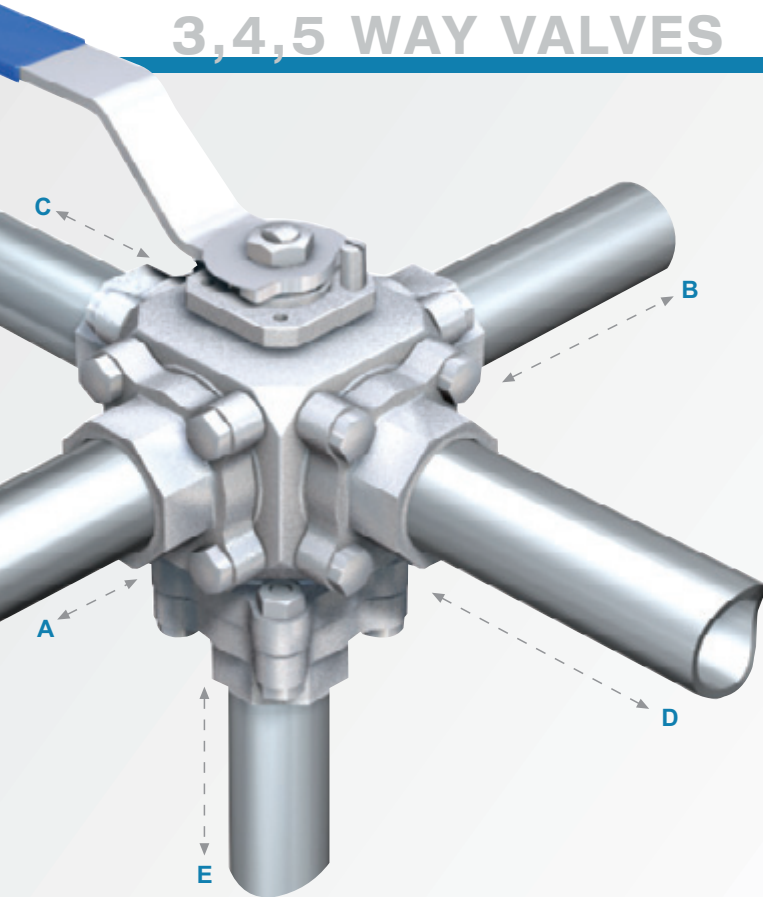

**3 Way Valves - Side Entry**  
Product index ..... p. 4-5

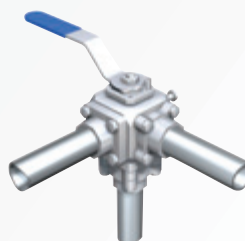

**3 Way Valves - Bottom Entry**  
Product index ..... p. 5



**3 Way Valves - Bottom Entry**  
Product index ..... p. 5

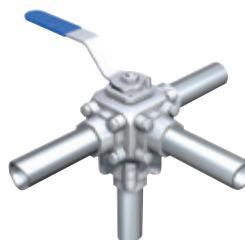

**4 Way Valves - Bottom Entry**  
Product index ..... p. 6-7

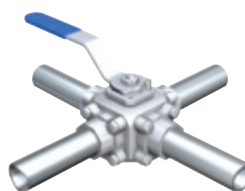

**4 Way Valves - Side Entry**  
Product index ..... p. 8

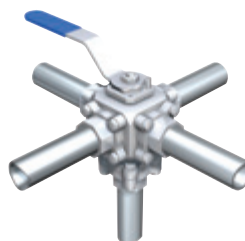

**5 Way Valves**  
Product index ..... p. 9

## Contents

- Introduction ..... Page 2-3
- Product Index ..... Page 4-9
- Dimensions ..... Page 10-13
- Automated Valves ..... Page 14
- Technical Data ..... Page 15
- How to Order ..... Page 16

## 3,4,5 WAY VALVES

Habonim's 61P/62P Series, multi-port 3, 4 and 5-way ball valves, provide high performance and high reliability coupled with wide-ranging flow versatility. The 61P/62P Series provides a diverse selection of flow-patterns, rotation angles and end configurations to choose from, making it the ideal multi-port ball valve solution for even the most demanding mixing and diverting applications.

## Technical Summary

<b>Size Range:</b>	¾" (½" FB) - 4" (DN20 - DN100)
<b>Materials*:</b>	Stainless Steel, Hastelloy C22
<b>End Connections:</b>	Screwed, Socket & Butt weld, Flanged, Clamp, Compression Fitting, Tube
<b>Applications:</b>	General Service, Chemical, Petrochemical, Oil & Gas, Refinery
<b>Service:</b>	Water, Gas, Chemicals, Solvents
<b>Operation:</b>	Manual or Actuated
<b>Service Operation:</b>	Diversion, Mixing, Blending

\* Other materials available on request.

### Ball types

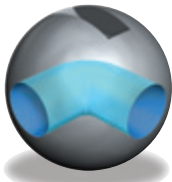

L - Horizontal

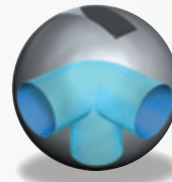

LL

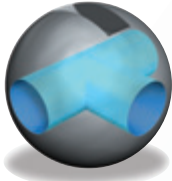

T - Horizontal

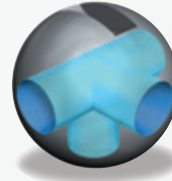

TT

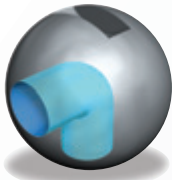

L - Vertical

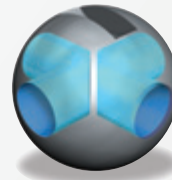

X (LL)

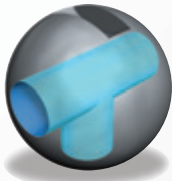

T - Vertical

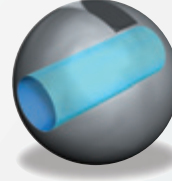

I

### How To Use The Product Index Pages 4-9

1 Select the valve Type



3 Way Valves - Side Entry

4 Select rotation direction (ccw/cw)

CCW

CW

2 Select the ball type

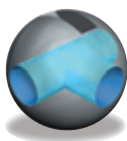

T - Horizontal

5 Select starting position and flow pattern



Flow is indicated by a blue pipeline.

3 Select rotation angle

90°

180°

360°

6 Use flow pattern code Number to order the appropriate valve

90°	CCW <input type="radio"/>				CW <input checked="" type="radio"/>			
	# 001	# 002	# 003	# 004	# 005	# 006	# 007	# 008
Start								
2nd								

# 3,4,5 WAY VALVES > Product Index

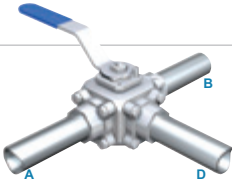

**3 Way Valve - Side Entry**

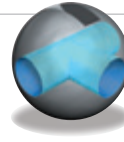

**T - Horizontal**

90°	CCW ⌚				CW ⌚			
	# 001	# 002	# 003	# 004	# 005	# 006	# 007	# 008
Start								
2 <sup>nd</sup>								

180°	CCW ⌚				CW ⌚			
	# 009	# 010	# 011	# 012	# 013	# 014	# 015	# 016
Start								
2 <sup>nd</sup>								
3 <sup>rd</sup>								

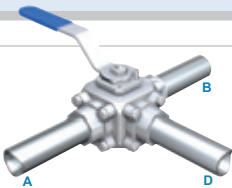

**3 Way Valve - Side Entry**



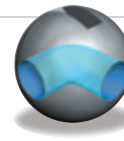









**L - Horizontal**

90°	CCW ⌚			CW ⌚	
	# 019	# 020	# 021	# 022	# 024
Start					
2 <sup>nd</sup>					

  

180°	CCW ⌚		CW ⌚	
	# 025	# 026	# 027	# 028
Start				
2 <sup>nd</sup>				
3 <sup>rd</sup>				

360°	CCW 	CW 
	# 017	# 018
Start		
2 <sup>nd</sup>		
3 <sup>rd</sup>		
4 <sup>th</sup>		

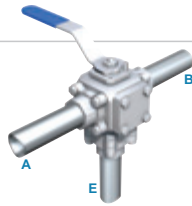

**3 Way Valve  
Bottom Entry**

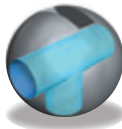

**T - Vertical**

90°	CCW 
	# 029
Start	
2 <sup>nd</sup>	

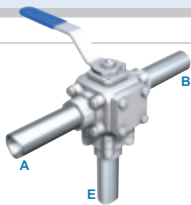

**3 Way Valve  
Bottom Entry**

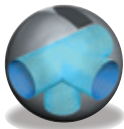

**TT**

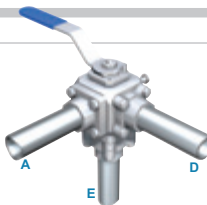

180°	CCW 
	# 030
Start	
2 <sup>nd</sup>	
3 <sup>rd</sup>	

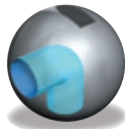

**3 Way Valve  
Bottom Entry**



**L - Vertical**

90°	CCW 
	# 031
Start	
2 <sup>nd</sup>	



# 3,4,5 WAY VALVES > Product Index

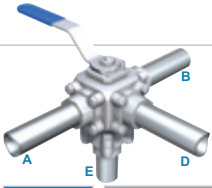

## 4 Way Valve - Bottom Entry

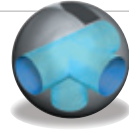

TT

90°	CCW ◯				CW ◯			
	# 032	# 033	# 034	# 035	# 036	# 037	# 038	# 039
Start								
2 <sup>nd</sup>								

180°	CCW ◯				CW ◯			
	# 040	# 041	# 042	# 043	# 044	# 045	# 046	# 047
Start								
2 <sup>nd</sup>								
3 <sup>rd</sup>								

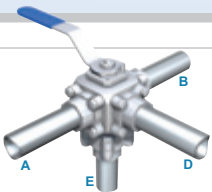

## 4 Way Valve - Bottom Entry



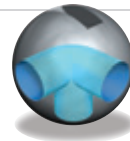





LL

90°	CCW ◯
	# 050
Start	
2 <sup>nd</sup>	

  

180°	CCW ◯				CW ◯			
	# 051	# 052	# 053	# 054	# 055	# 056	# 057	# 058
Start								
2 <sup>nd</sup>								
3 <sup>rd</sup>								

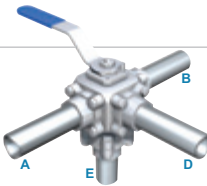

360°	CCW 	CW 
		# 048
Start		
2 <sup>nd</sup>		
3 <sup>rd</sup>		
4 <sup>th</sup>		



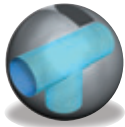

### 4 Way Valve Bottom Entry



### T - Vertical

90°	CCW 
Start	
2 <sup>nd</sup>	



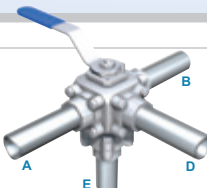



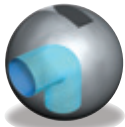



360°	CCW 	CW 
		# 059
Start		
2 <sup>nd</sup>		
3 <sup>rd</sup>		
4 <sup>th</sup>		



### 4 Way Valve Bottom Entry



### L - Vertical

360°	CCW 	CW 
		# 062
Start		
2 <sup>nd</sup>		
3 <sup>rd</sup>		
4 <sup>th</sup>		

# 3,4,5 WAY VALVES > Product Index

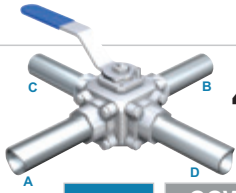

## 4 Way Valve- Side Entry

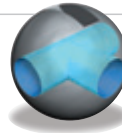

## T - Horizontal

90°	CCW ◯	CW ◯
	# 064	# 065
Start		
2 <sup>nd</sup>		

180° 2 positions	CW ◯
	# 066
Start	
2 <sup>nd</sup>	

180° 3 positions	CCW ◯	CW ◯
	# 067	# 068
Start		
2 <sup>nd</sup>		
3 <sup>rd</sup>		

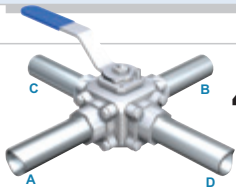

## 4 Way Valve- Side Entry

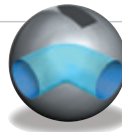

## L - Horizontal

180°	CCW ◯
	# 069
Start	
2 <sup>nd</sup>	

360°	CCW ◯	CW ◯
	# 070	# 071
Start		
2 <sup>nd</sup>		
3 <sup>rd</sup>		
4 <sup>th</sup>		

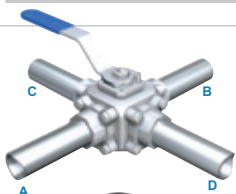

## 4 Way Valve Side Entry

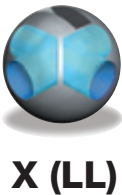

90°	CCW ◯
	# 072
Start	
2 <sup>nd</sup>	

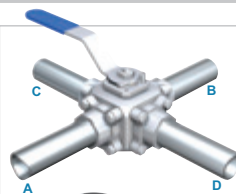

## 4 Way Valve Side Entry

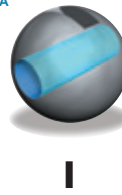

90°	CCW ◯
	# 073
Start	
2 <sup>nd</sup>	



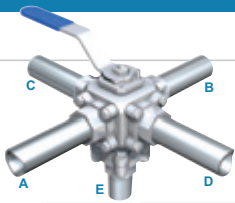

### 5 Way Valve - Bottom Entry

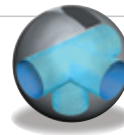

**TT**

90°	CCW ○	CW ○	180°	CCW ○	CW ○	360°	CCW ○	CW ○
	# 074	# 075		# 076	# 077		# 078	# 079
Start			Start			Start		
2 <sup>nd</sup>			2 <sup>nd</sup>			2 <sup>nd</sup>		
			3 <sup>rd</sup>			3 <sup>rd</sup>		
						4 <sup>th</sup>		

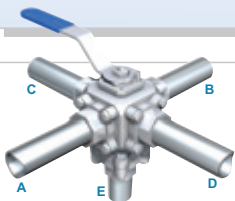

### 5 Way Valve Bottom Entry

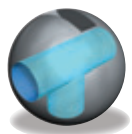

**T - Vertical**

90°	CCW ○
Start	# 080 
2 <sup>nd</sup>	

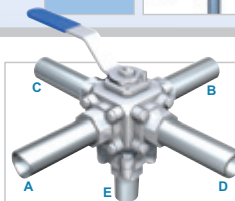

### 5 Way Valve Bottom Entry

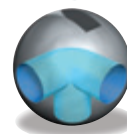

**LL**

180° 2 positions	CCW ○
Start	# 083 
2 <sup>nd</sup>	

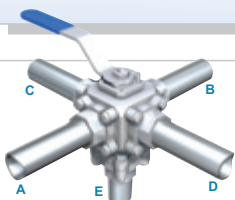

### 5 Way Valve Bottom Entry

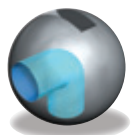

**L - Vertical**

360°	CCW ○	CW ○
	# 081	# 082
Start		
2 <sup>nd</sup>		
3 <sup>rd</sup>		
4 <sup>th</sup>		

360°	CCW ○	CW ○
	# 084	# 085
Start		
2 <sup>nd</sup>		
3 <sup>rd</sup>		
4 <sup>th</sup>		

# 3,4,5 WAY VALVES

## Valve Specification 3/4"- 2 1/2" (DN20-DN65)

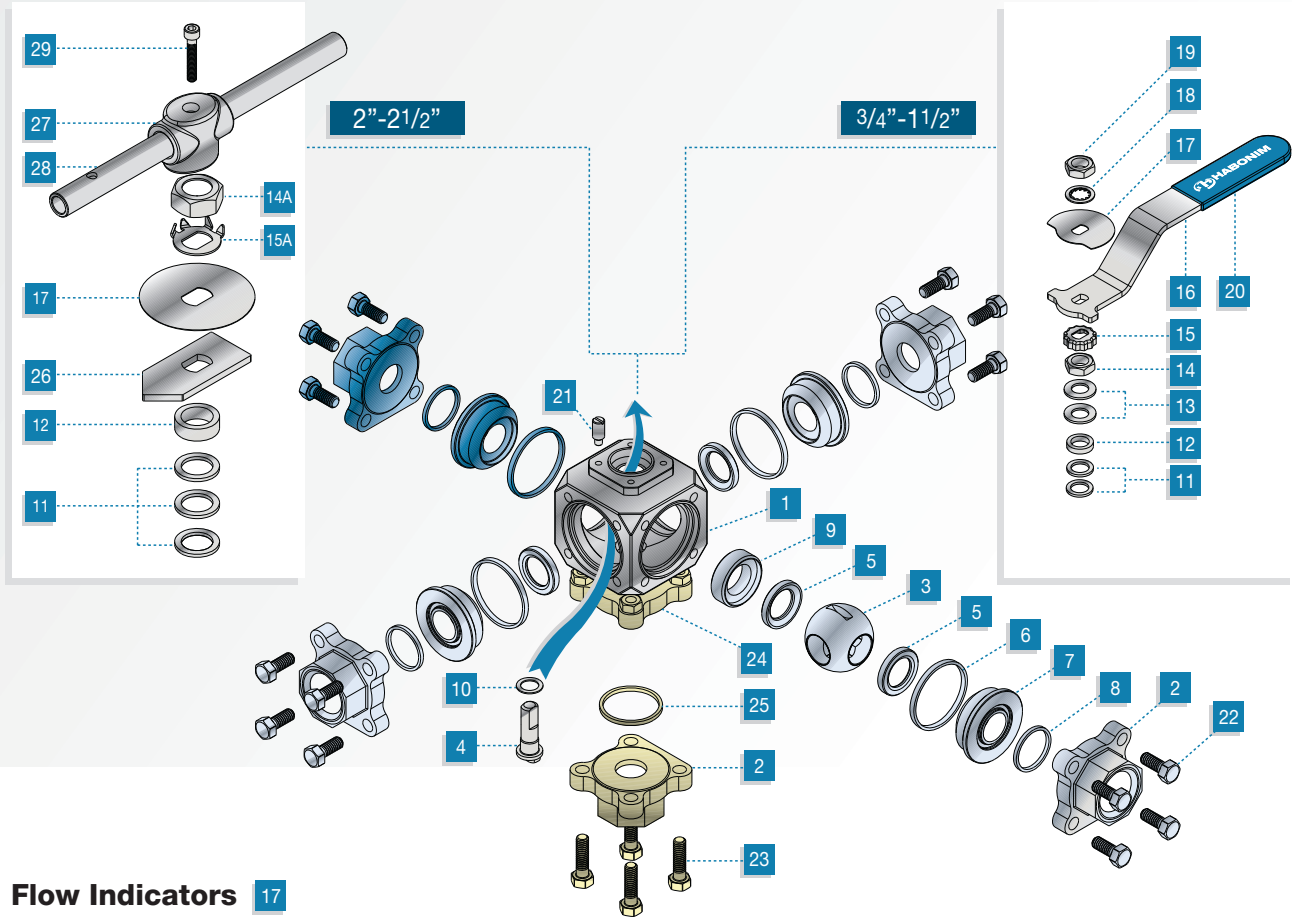

### Flow Indicators 17

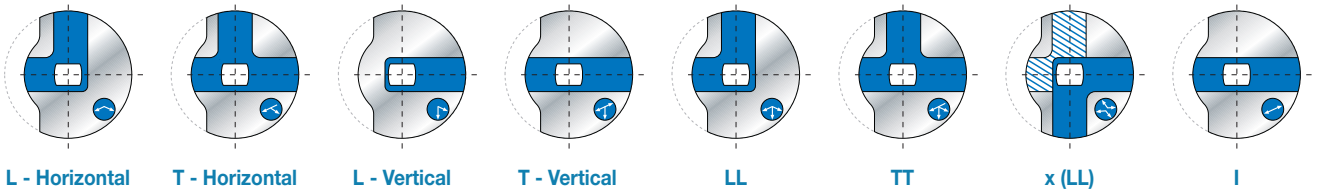

Item	Description	Material Specifications	Qty.			
			61P (D61P)		62P (D62P)	
			3/4"-1 1/2"	2" & 2 1/2"	3/4"-1 1/2"	2" & 2 1/2"
1	Body	Stainless St. ASTM A351 CF8M	1	1	1	1
2	End connector	Stainless St. ASTM A351 CF3M / CF8M	3 (4)	3 (4)	4 (5)	4 (6)
3	Ball	Stainless St. ASTM A276 316 L or A351 CF3M	1	1	1	1
4	Stem	Stainless St. ASTM A276 316 / 316L Stainless St. 17-4PH	1	1	1	1
*5	Seat**	PTFE, RPTFE, NRG, TFM, UHMWPE	4	4	4	4
*6	Body seal	PTFE, NRG, TFM, UHMWPE	3	3	4	4
7	Support ring	Stainless St. ASTM A276 316L	3	3	4	4
*8	Support seal	PTFE, Graphite, UHMWPE	3	3	4	4
9	Back up ring	Stainless St. ASTM A276 316L	1	1		
*10	Stem thrust seal	NRG, RPTFE, TFM, UHMWPE	1	1	1	1
*11	Stem packing	NRG, RPTFE, TFM, UHMWPE Graphite	2	3	2	3
12	Follower	Stainless St. ASTM B783 316L	1	1		
13	Disc springs	Stainless St. ASTM-A693 17-7PH	2		2	
14	Stem nut	Stainless St. ASTM A194 316	1		1	

\* Standard items for repair kits

\*\* Cavity filler seat not available

Item	Description	Material Specifications	Qty.			
			61P (D61P)		62P (D62P)	
			3/4"-1 1/2"	2" & 2 1/2"	3/4"-1 1/2"	2" & 2 1/2"
14A	Stem nut	C/S ZINC plated				
15	Locking clip	Stainless St. ASTM A164 304	1		1	
15A	Tab lock washer	Stainless St. ASTM A240 304		1		1
16	Handle	Stainless St. ASTM A240 430	1		1	
17	Flow indicator	Stainless St. ASTM A240 304	1	1		
18	Serrated washer	Stainless St. AISI 410	1		1	
19	Handle nut	Stainless St. ASTM A194 316	1		1	
20	Handle sleeve	Vinyl Plastisol	1		1	
21	Stop pin	Stainless St. ASTM A582 303	1	2	1	2
22	Body bolt	Stainless St. ISO 4014 A2-70	12	12	16	16
23	Diverter bolts	Stainless St. ISO 4014 A2-70	4	4	4	4
24	Diverter nuts	Stainless St. ASTM A194 316	4	4	4	4
25	Diverter seal	PTFE, Graphite, UHMWPE	1	1	1	1
26	Stop plate	Carbon St. ST37 ZINC plated		1		1
27	Tee wrench	ASTM A47 maleable iron		1		1
28	Wrench handle	Carbon St. ZINC plated		1		1
29	Wrench bolt	Stainless St. ISO 4014 A2-70		1		1

### Valve Dimensions 3/4"- 1 1/2" (DN20-DN40)

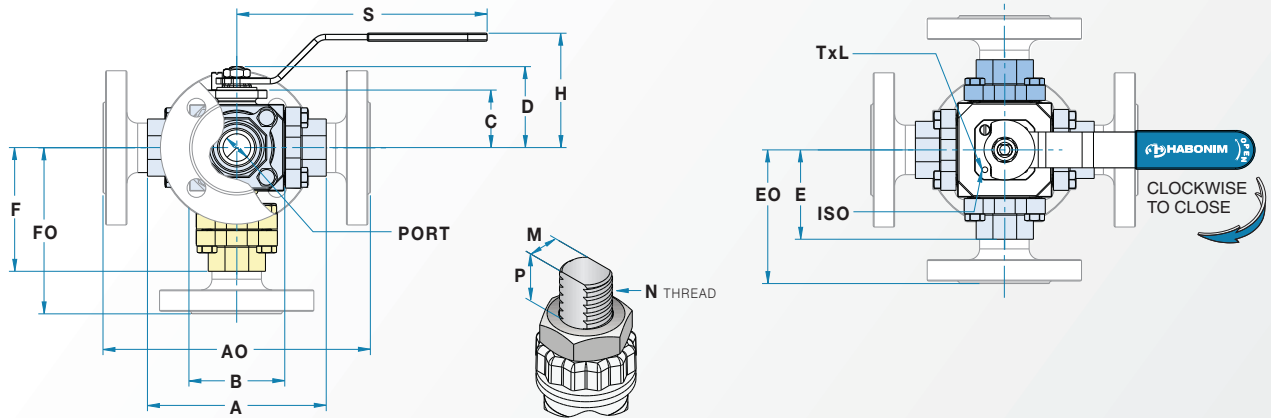

Valve Size	Unit	Port	A	A0			B	C	D	E (E0)	F	F0			H	M	N	P	TxL	ISO	S	Weight
				ANSI 150	ANSI 300	PN16 PN40						ANSI 150	ANSI 300	DIN								
3/4"	mm	14.3	108.0	154.5	190.0	187.5	62.0	37.5	55.0	A/2	110.5	133.7	151.5	150.2	80.0	7.54	3/8" UNF	7.0	M5	F04	187.0	2.75-5.8 Kg
	inch	0.562	4.252	6.082	7.480	7.381	2.44	1.476	2.165		4.350	5.263	5.964	5.913	3.149	0.297						
1"	mm	20.6	135.0	167.0	205.0	200.0	71.6	43.0	60.5	A/2	93.2	109.2	128.2	125.7	85.5	7.54	3/8" UNF	7.0	M5	F04	187.0	4.0-9.5 Kg
	inch	0.811	5.314	6.574	8.070	7.874	2.818	1.692	2.381		3.669	4.299	5.047	4.948	3.366	0.297						
1 1/4"	mm	25.5	144.0	174.5	205.5	207.5	76.0	48.0	65.5	A/2	102.0	117.2	132.7	133.7	90.0	7.54	3/8" UNF	7.0	M5	F04	187.0	5.8-10.0 Kg
	inch	1.00	5.669	6.870	8.090	8.169	2.992	1.889	2.578		4.015	4.614	5.224	5.263	3.543	0.297						
1 1/2"	mm	31.65	158.0	208.0	233.5	243.0	91.0	49.5	79.0	A/2	106.0	131.0	143.7	148.5	103.0	8.71	3/8" UNF	10.0	M6x9	F05	236.0	7.5-15.0 Kg
	inch	1.246	6.220	8.188	9.192	9.566	3.582	1.948	3.110		4.173	5.157	5.657	5.846	4.055	0.343						

### Valve Dimensions 2"- 2 1/2" (DN50-DN65)

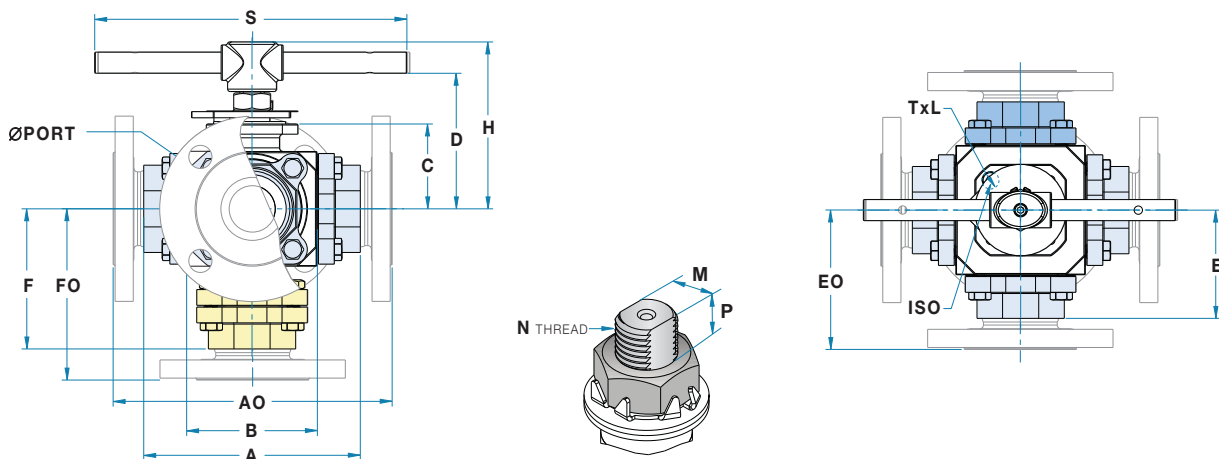

Valve Size	Unit	Port	A	A0			B	C	D	E (E0)	F	F0			H	M	N	P	TxL	ISO	S	Weight	
				ANSI 150	ANSI 300	PN16 PN40						ANSI 150	ANSI 300	PN16 PN40									
2"	mm	38.1	178.0	228.7	266.8	280.9	107.2	69.6	111.2	A/2	115.0	140.5	159.5	166.3	139.4	13.92	M20 x	0.594	M8	Thru	F07	255.0	13.5-23.0 Kg
	inch	1.50	7.0	9.0	10.5	11.05	4.22	2.74	4.37		4.52	5.53	6.27	6.54	5.48	0.548							
2 1/2"	mm	50.8	210.4	242.9	293.7	342.4	125.0	78.5	120.1	A/2	143.2	159.5	184.8	209.2	150.9	13.92	2.5-6g	15.1	M8	Thru	F07	255.0	21.0-39.0 Kg
	inch	2.0	8.28	9.56	11.56	13.48	4.92	3.09	4.72		5.63	6.27	7.27	8.23	5.94	0.548							

# 3,4,5 WAY VALVES

## Valve Specification 3"- 4" (DN 80-DN100)

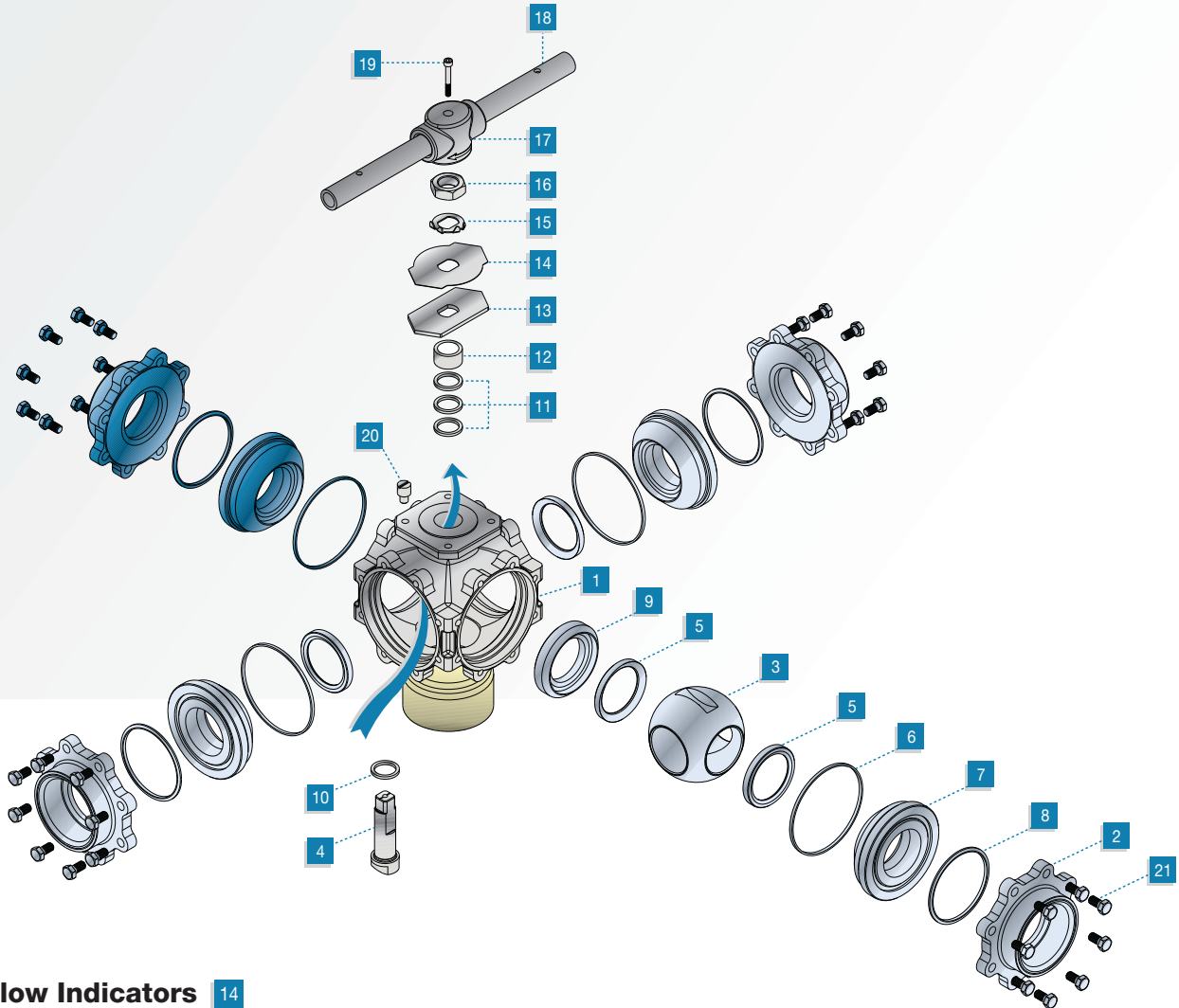

### Flow Indicators 14

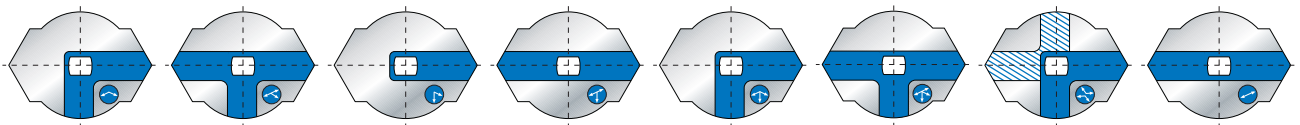

L - Horizontal

T - Horizontal

L - Vertical

T - Vertical

LL

TT

x (LL)

I

Item	Description	Material Specifications	Qty.	
			61P (D61P)	62P (D62P)
1	Body	Stainless St. ASTM A351 CF8M	1	1
2	End connector	Stainless St. ASTM A351 CF3M	3	4
3	Ball	Stainless St. ASTM A276 316 \ 316L or A351 CF8M \ CF3M	1	1
4	Stem	Stainless St. ASTM A276 316 / 316L	1	1
*5	Seat**	PTFE, RPTFE, NRG, TFM	4	4
*6	Body seal	PTFE, TFM	3	4
7	Support ring	Stainless St. ASTM A276 316L	3	4
*8	Support seal	PTFE	3	4
9	Back up ring	Stainless St. ASTM A276 316L	1	1
*10	Stem thrust seal	NRG, RPTFE, TFM	1	1

\* Standard items for repair kits

\*\* Cavity filler seat not available

Item	Description	Material Specifications	Qty.	
			61P (D61P)	62P (D62P)
*11	Stem packing	NRG, RPTFE, TFM Graphite	3	3
12	Follower	Stainless St. ASTM B783 316L	1	1
13	Stop plate	Carbon St. ST 37 ZINC plated	1	1
14	Flow indicator	Stainless St. ASTM A240 304	1	1
15	Tab lock washer	Stainless St. ASTM A240 304	1	1
16	Stem nut	Carbon St. ZINC plated	1	1
17	Wrench tee head	ASTM A47 maleable iron	1	1
18	Wrench handle	Carbon St. ZINC plated	1	1
19	Wrench bolt	Stainless St. ISO 4014 A2-70	1	1
20	Stop pin	Stainless St. ASTM A582 303	2	2
21	Body bolt	Stainless St. ISO 4014 A2-70	24	32

### Valve Dimensions 3"- 4" (DN80-DN100)

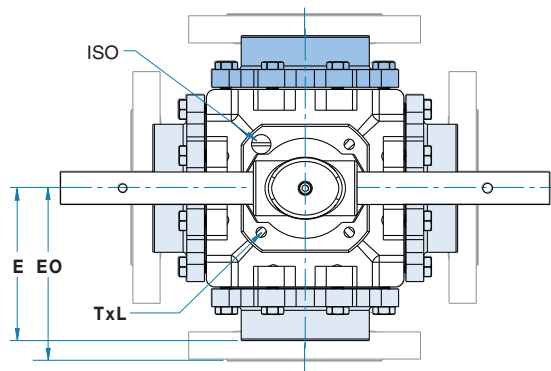
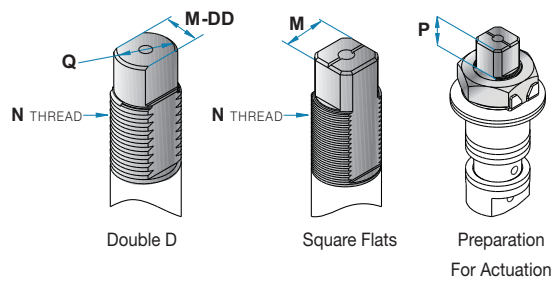
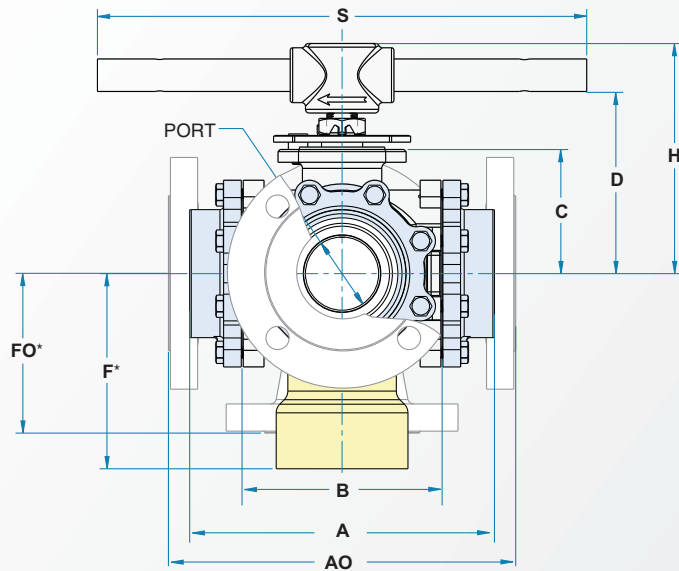

Valve Size	Unit	Port	A		A0			B	C	D	E (E0)	H	M	M-DD	N	P	Q	TxL	ISO	S	Weight
			ANSI 150	ANSI 300	PN16	PN40															
3"	mm	60.0	250.0	283.9	363.2	390.6	164.0	102.0	149.0	A/2 (A0/2)	189.0	18.9	15.9	1"-14	16.6	22.7	M10x20	F10	610.0	36-52 Kg	
	inch	2.36	9.84	11.17	14.29	15.37	6.45	4.01	5.86		7.44	0.744	0.626	UNS-2A	0.653	0.894			24.0		
4"	mm	82.8	309.8	324.8	401.0	446.2	205.0	116.7	168.0	A/2 (A0/2)	202.65	18.9	15.9	1"-14	16.6	22.7	M10x20	F10	610.0	60-85 Kg	
	inch	3.25	12.19	12.19	15.78	17.56	8.07	4.59	6.61		7.97	0.744	0.626	UNS-2A	0.653	0.894			24.0		

\* Consult HABONIM

# 3,4,5 WAY VALVES

## 61P/62P Series Automated Valves Dimensions

### Actuation

Where automation is required, the 61P/62P series ball valves are available with Habonim's unique 4-Piston pneumatic Compact actuator. The Compact actuator is available in 8 sizes, spring return or double acting. All the valve mounting flanges are according to ISO 5211 and are suitable for accommodating any quarter turn actuator (pneumatic or electric) for valve automatization. Valves can be operated for on-off or throttling application. The actuators have a NAMUR air connection interface for attaching solenoids. Limit switches and positioners can be mounted on the actuator top face according to VDI / VDE 3845. For information, please refer to Bulletin B360.

### Actuator Sizing

Valve sizing tables of the Compact actuators on Habonim valves are available on request. The sizing tables are based on valve size, differential pressure, valve seat types, working temperature, flowing media and frequency of operation. The valve torque figures are calculated from tests using water at room temperature at different pressure drops for each seat material and actuator air pressure. Please consult with HABONIM for more details.

3/4" - 2 1/2" (DN20-DN65)

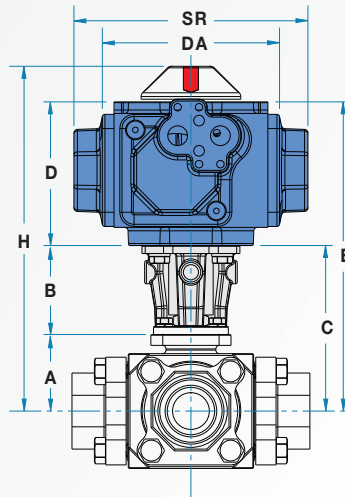

3" - 4" (DN80-DN100)

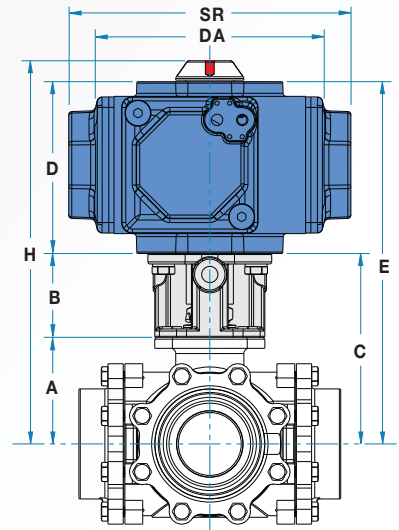

### Compact Flow Direction Indicator Options

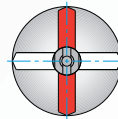

I (Straight)

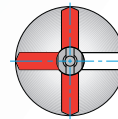

T (3-Way)

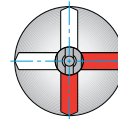

L (2-Way 90 DEG)  
X (4-Way)

VALVE SIZE	ACTUATOR SIZE	61P SERIES					COMPACT ACTUATOR		
		A	B	C	E	H	D	DA	SR
3/4" F04	C20	38.15	50.0	88.2	168.9	188.9	80.7	102.0	131.0
	C25		50.0	88.2	185.4	205.4	97.2	132.0	161.0
1" F04	C20	43.0	50.0	93.0	173.7	193.7	80.7	102.0	131.0
	C25		50.0	93.0	190.2	210.2	97.2	132.0	161.0
	C30		50.0	93.0	209.6	229.6	116.6	151.0	186.0
1 1/4" F04	C25	48.0	50.0	98.0	195.2	215.2	97.2	132.0	161.0
	C30		50.0	98.0	214.6	234.6	116.6	151.0	186.0
1 1/2" F05	C25	49.4	60.0	109.4	206.6	226.6	97.2	132.0	161.0
	C30		60.0	109.4	226.0	246.0	116.6	151.0	186.0
	C35		60.0	109.4	244.9	264.9	135.5	182.0	222.0
2" F07	C25	69.6	60.0	129.6	226.8	246.8	97.2	132.0	161.0
	C30		60.0	129.6	246.2	266.2	116.6	151.0	186.0
	C35		60.0	129.6	265.1	285.1	135.5	182.0	222.0
	C45		60.0	129.6	293.6	313.6	164.0	221.0	269.0
2 1/2" F07	C30	78.5	60.0	138.5	255.1	275.1	116.6	151.0	186.0
	C35		60.0	138.5	274.0	294.0	135.5	182.0	222.0
	C45		60.0	138.5	302.5	322.5	164.0	221.0	269.0
3" F10	C30	101.75	80.0	181.8	298.4	318.4	116.6	151.0	186.0
	C35		80.0	181.8	317.3	337.3	135.5	182.0	222.0
	C45		80.0	181.8	345.8	365.8	164.0	221.0	269.0
	C60		80.0	181.8	399.3	429.3	217.5	285.0	360.0
4" F10	C35	116.7	80.0	196.7	332.2	352.2	135.5	182.0	222.0
	C45		80.0	196.7	360.7	380.7	164.0	221.0	269.0
	C60		80.0	196.7	414.2	444.2	217.5	285.0	360.0
	C75		80.0	196.7	466.7	496.7	270.0	342.0	437.0



## Locking Device

### LLP (Locked in Last Position)

The Habonim spring loaded locking device (LD) is ideal for applications where it is critical to keep the valve position without the risk of accidental operation. The locking device fits easily to the valve stem by simply removing the stem nut and threading the lock stem above the handle. The LD can lock the valve in closed or open position. The LD can be fitted to the valve in-line. Available in sizes 3/4" to 1 1/2".

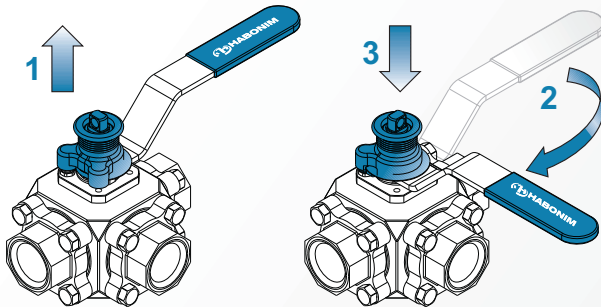

Valve in Open Position

Valve in Closed Position

While lifting the lock housing above the stop pin (1) turn the wrench (2) to its new position. When the handle is in its new position release the housing to fit on the stop pin (3).

## Mounting Actuators or Gear Operators

When preparing a valve for actuation, make sure to follow the instructions below.

### Stem arrangement for actuated valves

#### Valve sizes 3/4" to 1 1/2"

Release the handle nut (1) remove the serrated washer (2) the flow direction indicator (3) the handle (4) and the stop pin (5). Refasten the handle nut (1) on the locking clip (6).

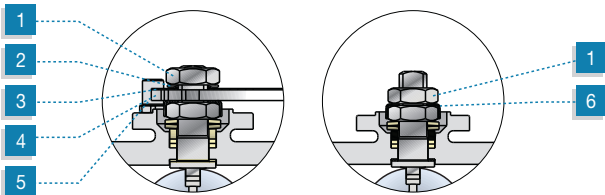

#### Valve sizes 2" to 4"

Release the T wrench bolt (1) and remove the wrench pipe handle (2), the T wrench (3). Release the tab lock washer (4) and remove the stem nut (5), the flow direction indicator (6), the stop plate (7) and the stop pin(S) (8). Assemble the 2 disc springs (9), the flat washer (10) and refasten the stem nut (5) and lock with the tab lock washer (4).

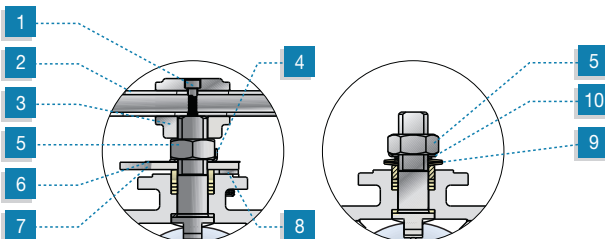

## Seats & Body Seals

The 61P / 62P series valves have 4 seats enabling better sealing characteristics. Seats are inserted into a support ring which is sealed with 2 separate body seals. One seals between the support ring and the body, and the other between the support ring & the end connector. Both body seals are encapsulated, and thus provide tighter compression of the seal for higher pressure & temperature fluctuations.

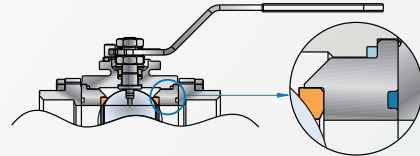

## Standards of Compliance

Design:	ANSI B16.34, ISO 17292 (BS 5351)
Threaded end connections:	NPT ANSI B1.20.1, BSPT ISO R/7 BS 21 DIN 2999
Socket Weld end connections:	BS 1600, API 5L, ANSI B16.11, DIN 3239 Pt 2
Buttweld End Connections: (Schedules 5, 10, 40, 80)	BS 1600, API 5L, ANSI B16.25 DIN 3239 Pt 1
Pressure testing:	API 598, BS EN 12266-1, EN 12266-1:2003, ISO 5208
Certification:	ISO 9001-2008, PED 97/23/EC Module H

## Pressure / Temperature Rating (Seat Material)

**A** TFM   **T** PTFE   **R** RPTFE   **P** NRG

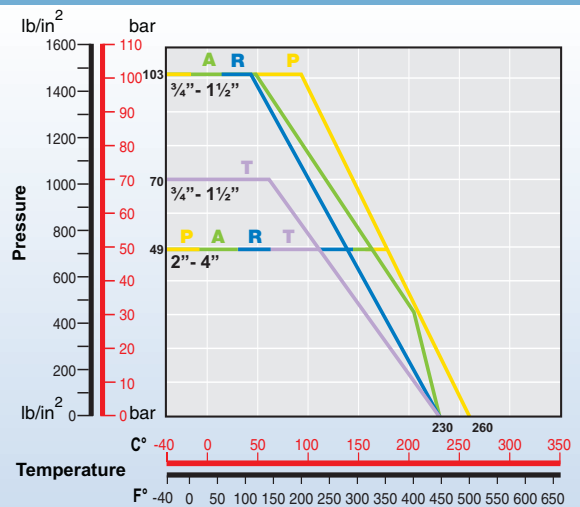

## Cv & limiting stem input torque

Valve Size	Cv Values				Limiting Stem Input Torque*			
	Straight flow pattern		L pattern		316 S/S		17-4PH	
	Cv	Kv	Cv	Kv	NM	in Lb	NM	in Lb
3/4"	11	9	8	7	24	216	165	1460
1"	31	27	22	19	24	216	165	1460
1 1/4"	55	47	39	33	24	216	165	1460
1 1/2"	78	67	55	47	49	430	268	2372
2"	101	87	71	61	99	875	497	4400
2 1/2"	233	201	163	141	99	875	497	4400
3"	310	267	217	187	385	3400	1920	17000
4"	562	484	393	339	385	3400	1920	17000

Cv - Flow in US GPM at 1 psi pressure drop.

Kv - Flow in m3/hr at 1 bar pressure drop.

Valve flow rates are determined in full open position with water at 15 C° (60 F°).

\* Limiting Stem torque figures are based on random laboratory tests.

These are not to be confused with valve operating torque.

# 3,4,5 WAY VALVES

61P/62P SERIES

## How to order The HABONIM 61P/62P Ball Valve Identification Code

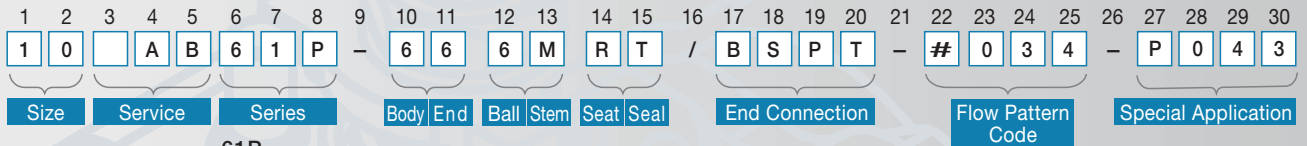

61P  
62P

Size			Service		Body / End Ball / Stem		Seat		Seal		End Connection		
Code	inch	mm	A	B	6	M	A	R	G	T	U	BSPT	BS 21
07	3/4"	20	A Anti Static	B Full Bore	6 Stainless Steel	M 17-4PH	A TFM	R 15% Glass Filled PTFE	G Graphite	T Virgin PTFE	U UHMWPE	DIN	DIN 2999 (BSPP)
10	1"	25	D Diverter	O Oxygen Service	W Hastelloy C22	T Virgin PTFE	T Virgin PTFE	T Virgin PTFE	T Virgin PTFE	T Virgin PTFE	U UHMWPE	NPT	B1.20.1
12	1 1/4"	32	V Vacuum Service	V Vacuum Service								BW	Buttweld Sch 5, 10, 40, 80
15	1 1/2"	40	W Steam & Thermal Fluid	W Steam & Thermal Fluid								XBW	Extended Buttweld
20	2"	50										SW	Socketweld
25	2 1/2"	65										XSW	Extended Socket Weld
30	3"	80										BWO	OD tube
40	4"	100										ETO	Extended OD tube
												SWO	Socketweld OD tube
												TC	Tri-Clamp
												KLM	Copper tube brazing
												ETB	Extended Copper tube
												LL	Let Lok (Inch)
												LM	Let Lok (Metric)
												PN40	Flanged DIN PN40
												150	Flanged # 150
												300	Flanged # 300

Flow Pattern Code	Special Application	
See index pages 5-9	P043	stem seal for vacuum & gas service
	J2N05	Jacketed valve, No. of Outlets, Type, Size
	EP	Electro Polish
	WR	DD Stem (for 3" and above)

Other end connections are available on request.

## How to order

When placing an order for HABONIM valves, please provide as many details possible on the application such as: Media, Temperature, Pressure, Pipe line size and type of connection.

### Example A: 10 B61P-666MRT/SW # 008

Size 1" (10), Full Bore (B), 3 Way (61P), S. St Body, Ends & Ball, 17-4PH stem (M), RPTFE Seats (R), PTFE Body Seals (T), Socket Weld ends (SW), Flow Pattern Code (# 008).

### Example B: 15D62P-6666AT/150 # 084

Size 1 1/2" (15), Diverter (D), 4 Way (62P), S. St Body, Ends, Ball & stem (6), TFM Seats (A), PTFE Body Seals (T), #150 Flanged Ends (150), Flow Pattern Code (# 084).

## Valve Options

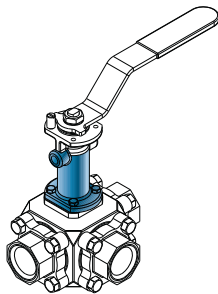

Fugitive Emission

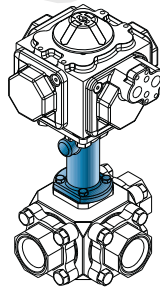

Fugitive Emission With Actuator

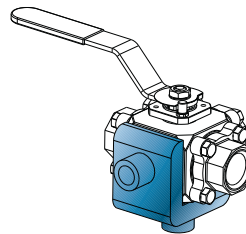

Steam Jacket

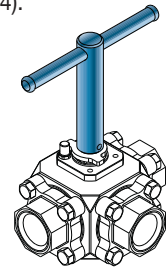

Extended Handle

TFM™ is a trademark of Dyneon

In accordance with our policy to strive for continuous improvement of the product, we reserve the right to alter the dimensions, technical data and information included in this catalogue when required.

Copyright © 2012 HABONIM Ltd. All rights reserved



**ISRAEL**  
Habonim Headquarter  
Tel: +972-4-6914911 / 6914903  
Fax: +972-4-6914935  
sales\_international@habonim.com

**U.K**  
Habonim UK  
Tel: +44-1633-484554  
Fax: +44-1633-482252  
sales\_uk@habonim.com

**USA**  
Habonim USA  
Toll Free Phone: 1-866-261-8400  
Toll Free Fax: 1-866-243-9959  
sales\_usa@habonim.com

**China**  
Habonim China  
Tel: + 86 21 64453190 \*146  
Fax: + 86 21 64453191  
sales\_china@habonim.com

CAT61PP-120M 01/14

www.habonim.com

MAXMARK